

Crusoe Power Management

Reducing x86 Operating Power Through LongRun Technology

Name: Marc Fleischmann

Title: Director, Low Power Programs

Company: Transmeta, Corp.

Crusoe, LongRun and Code Morphing
are trademarks of Transmeta Corp.

Pentium, Pentium Pro, Pentium II and Pentium III
are registered trademarks of Intel Corp.

Overview

- Key Challenges for Mobile Computing
 - “Portability” (weight) and “Ease of Use” (battery life)
 - Power consumption is the key limiting factor
- Solution - Crusoe Processor
 - Full compatibility with traditional x86 power management model
 - Significantly lower power
- LongRun
 - Transmeta’s new invention to drive power savings
 - Adaptive Power Control (performance on demand)
 - Advanced Thermal Control (thermal budget expansion)

Market Trends

The Internet Transforms the PC Market

Growth

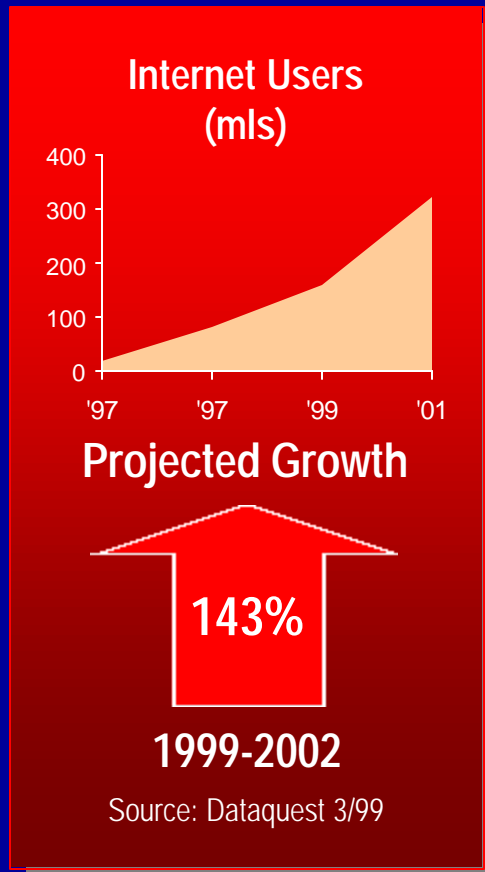

Capabilities



Thin & lights and Mini-Notebooks will be 65% of market by 2002

Thin & light becoming even thinner:
1-1.5" today
.85-1.25" in 2002

User Demands



Ease of use

93% say their battery "doesn't last long enough"

Portability

82% say their systems are "too heavy"

Source: IDC 12/99

Power Density

The Fundamental Problem

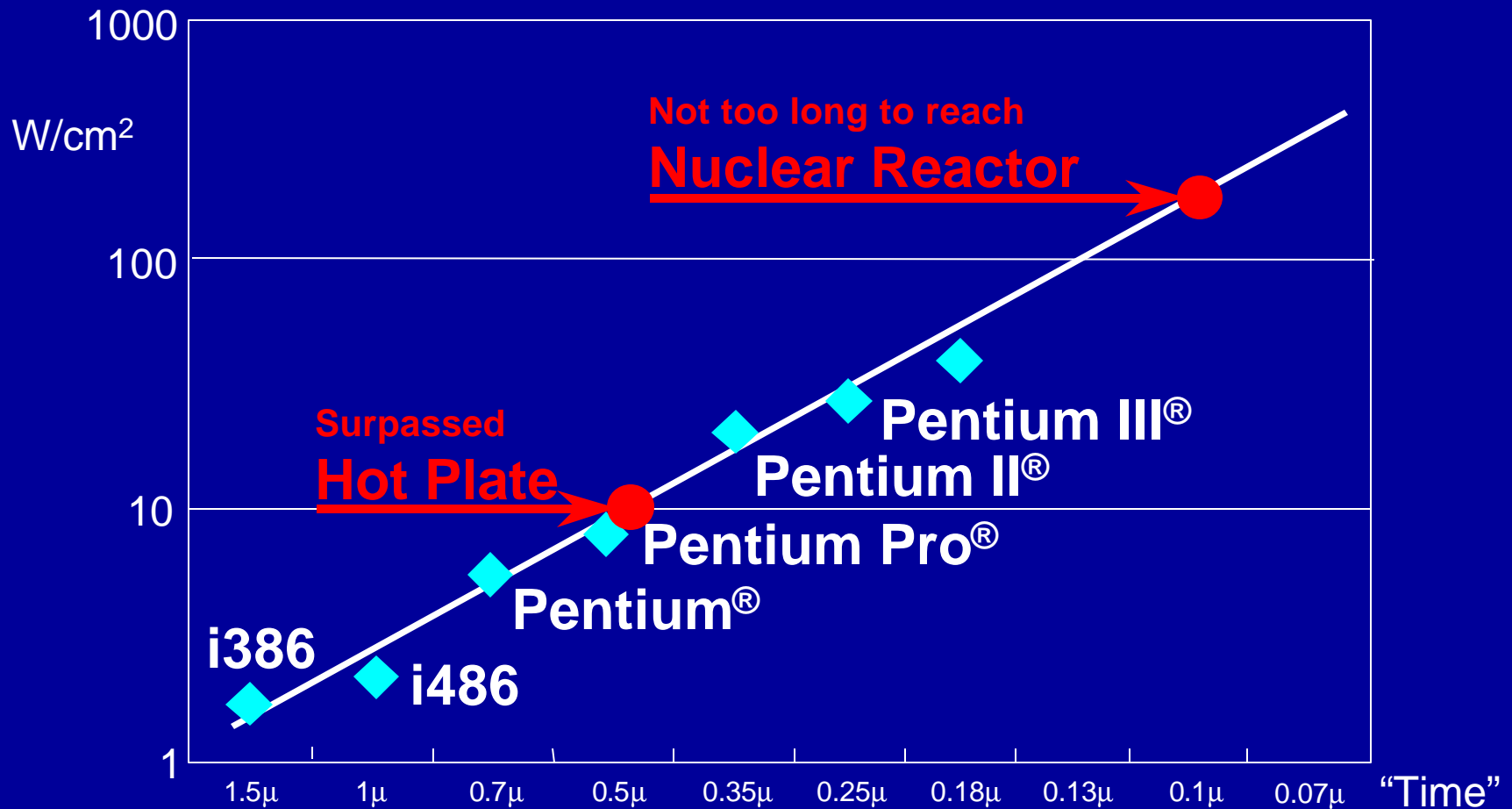

The Solution - Increase Efficiency

Crusoe - The Smart Microprocessor

$$P_{power} = C_{capacitance} \times V_{voltage}^2 \times F_{frequency}$$

- Transmeta Innovation - Code Morphing Software
- Effect - Replace Millions of Logic Transistors with Software
 - ... and transistors translate into capacitance
- Benefit - Significantly Reduces Power Consumption of x86 Power States

Power Comparison

Substantial Power Reduction by Crusoe

	Conventional Mobile x86 Solution			Crusoe TM5400 Integrated North Bridge		
	Processor 650 / 500 MHz 1.6 / 1.35 V	North Bridge 3.3 V	Total 650 / 500 MHz 1.6 / 1.35 V	LongRun 633 ↔ 300 MHz 1.6 ↔ 1.2 V		
Normal (C0)	14.0 / 8.0	2.0	16.0 / 10.0	6.5 ↔ 1.5		Watts
AutoHALT (C1)	1.7 / 1.1	2.0	3.7 / 3.1	0.9 ↔ 0.3		Watts
Quick Start (C2)	1.3 / 0.8	2.0	3.3 / 2.8	0.6 ↔ 0.2		Watts
Deep Sleep (C3)	0.5 / 0.3	~1.0	1.5 / 1.3	0.05 ↔ 0.05		Watts

- Crusoe plays Soft-DVD at the same power that conventional mobile x86 processors use in Deep Sleep!

LongRun Adaptive Power Control

Maximize Battery Life With Performance on Demand

$$Power = c \times v^2 \times f$$

- Dynamically adapt both frequency and voltage to performance demands
- Mechanisms in Hardware
 - Fully programmable
- Policies in CMS
 - Adapt f to demand
 - Reduce v proportionally
 - Cubic power savings!

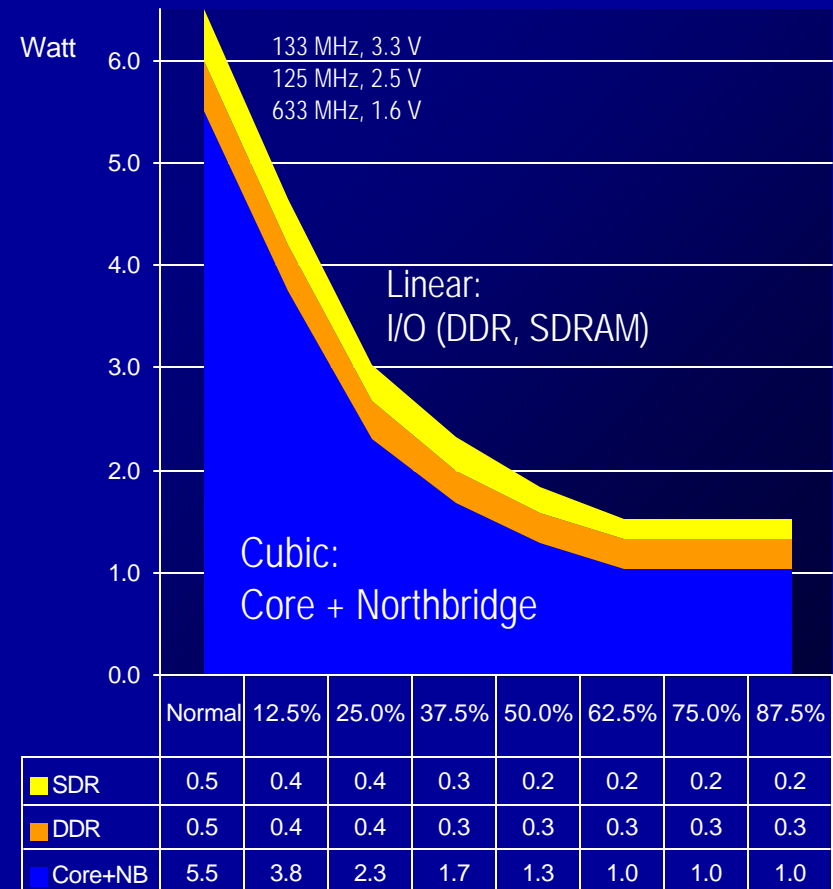

LongRun Adaptive Power Control vs. Traditional Power Management

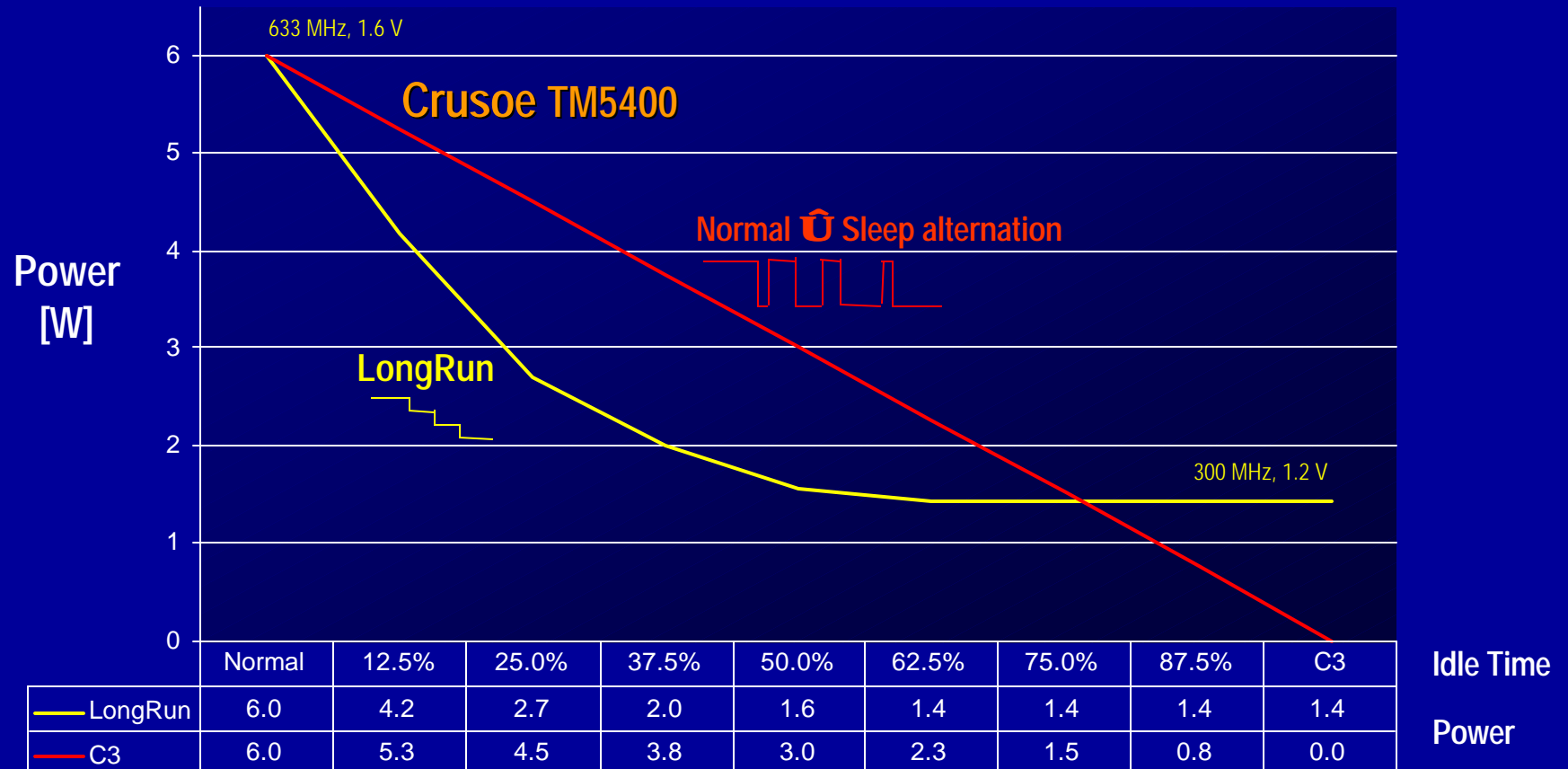

Notes

- 1 Power numbers include Northbridge
- 2 DDR-only configuration

LongRun Adaptive Power Control

Crusoe Power Profile

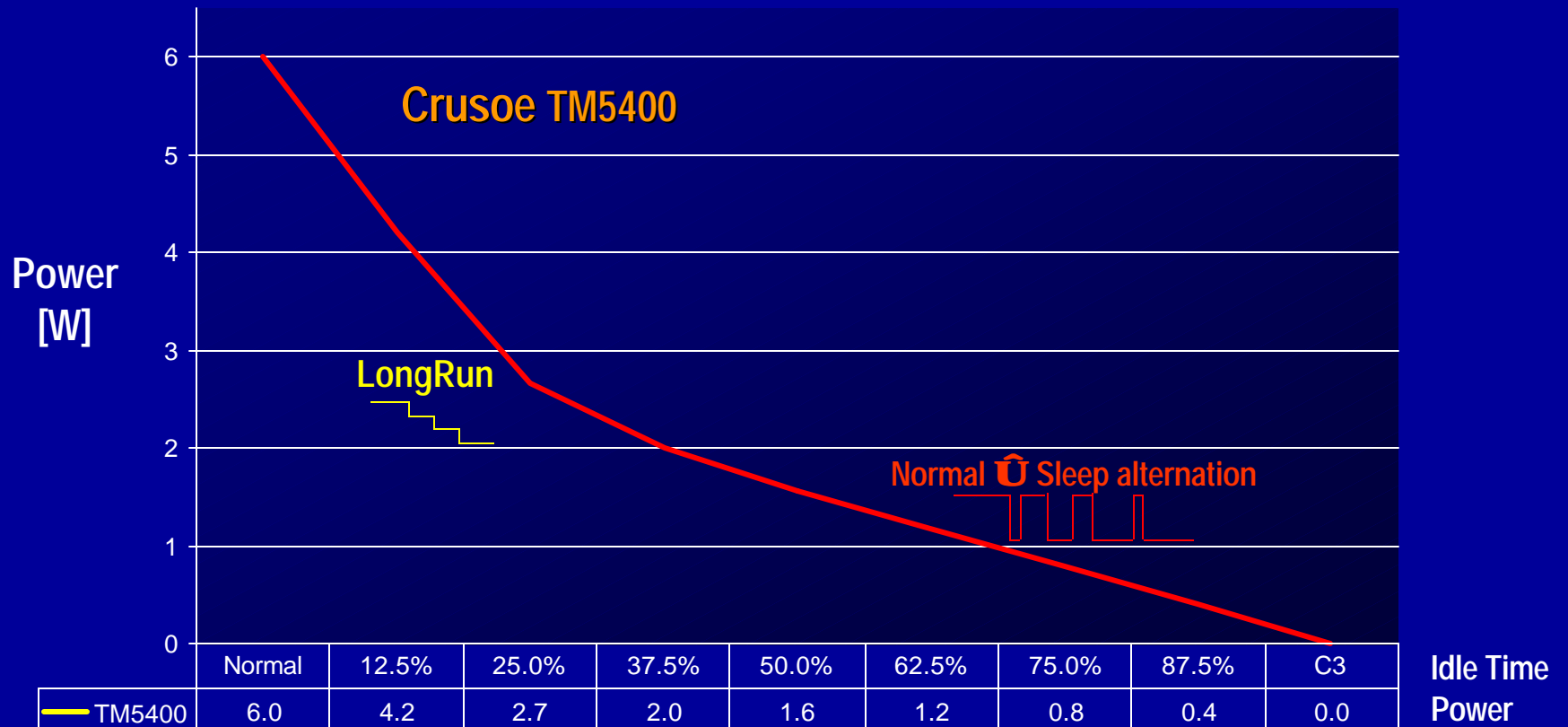

Notes

- 1 Power numbers include Northbridge
- 2 DDR-only configuration

The LongRun Effect

Power Profiles

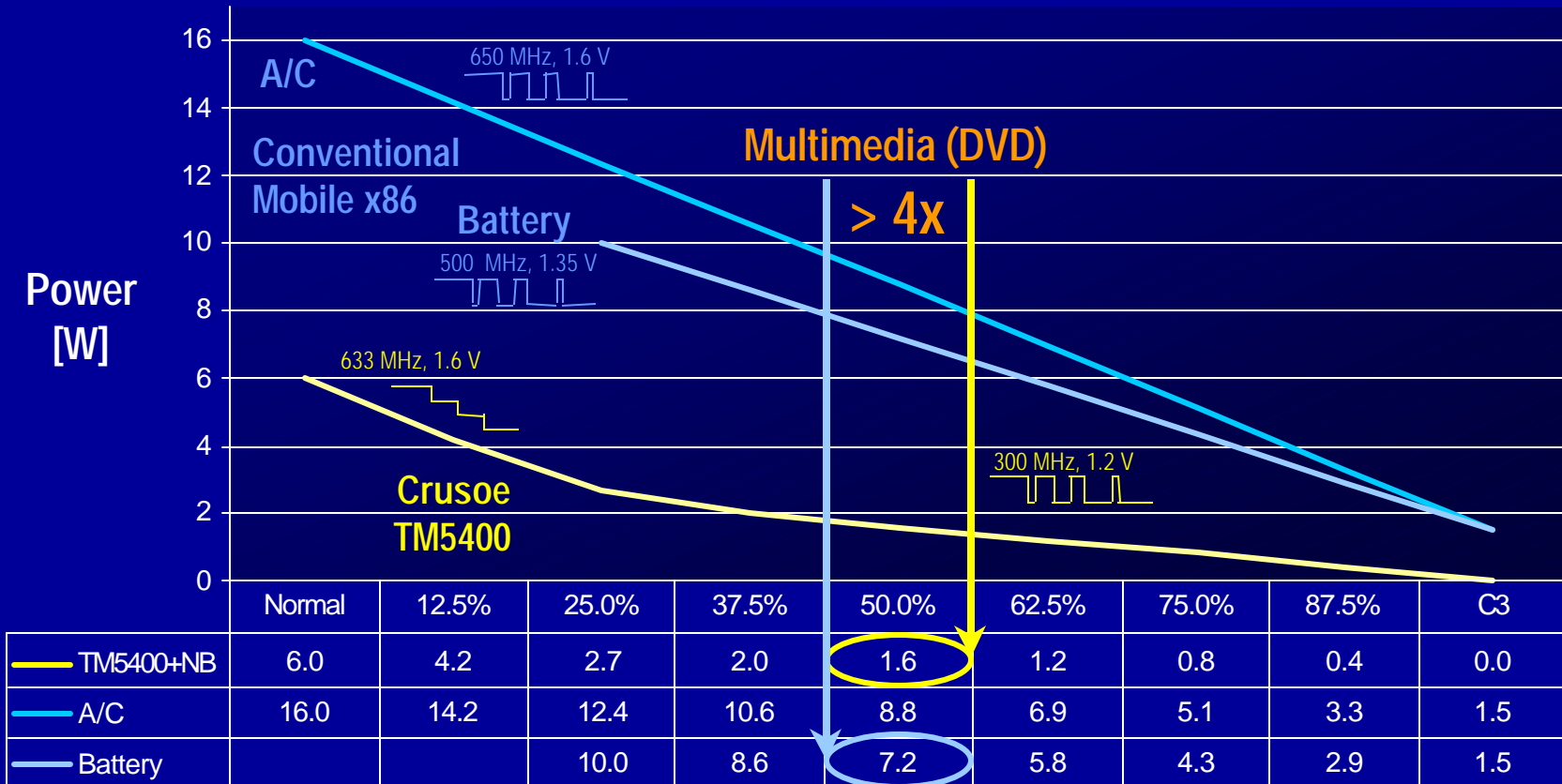

Notes

- 1 Power numbers include Northbridge
- 2 DDR-only configuration

System Architecture

Standard Applications

No changes required



Closed loop

Standard Operating System

No changes required

Closed loop

Standard BIOS

No changes required

Closed loop

Crusoe TM5400 processor featuring Transmeta LongRun technology

Code Morphing software monitors system activity and dynamically adapts LongRun performance levels

Performance on Demand

Duty Cycle \Leftrightarrow Effective Performance Level

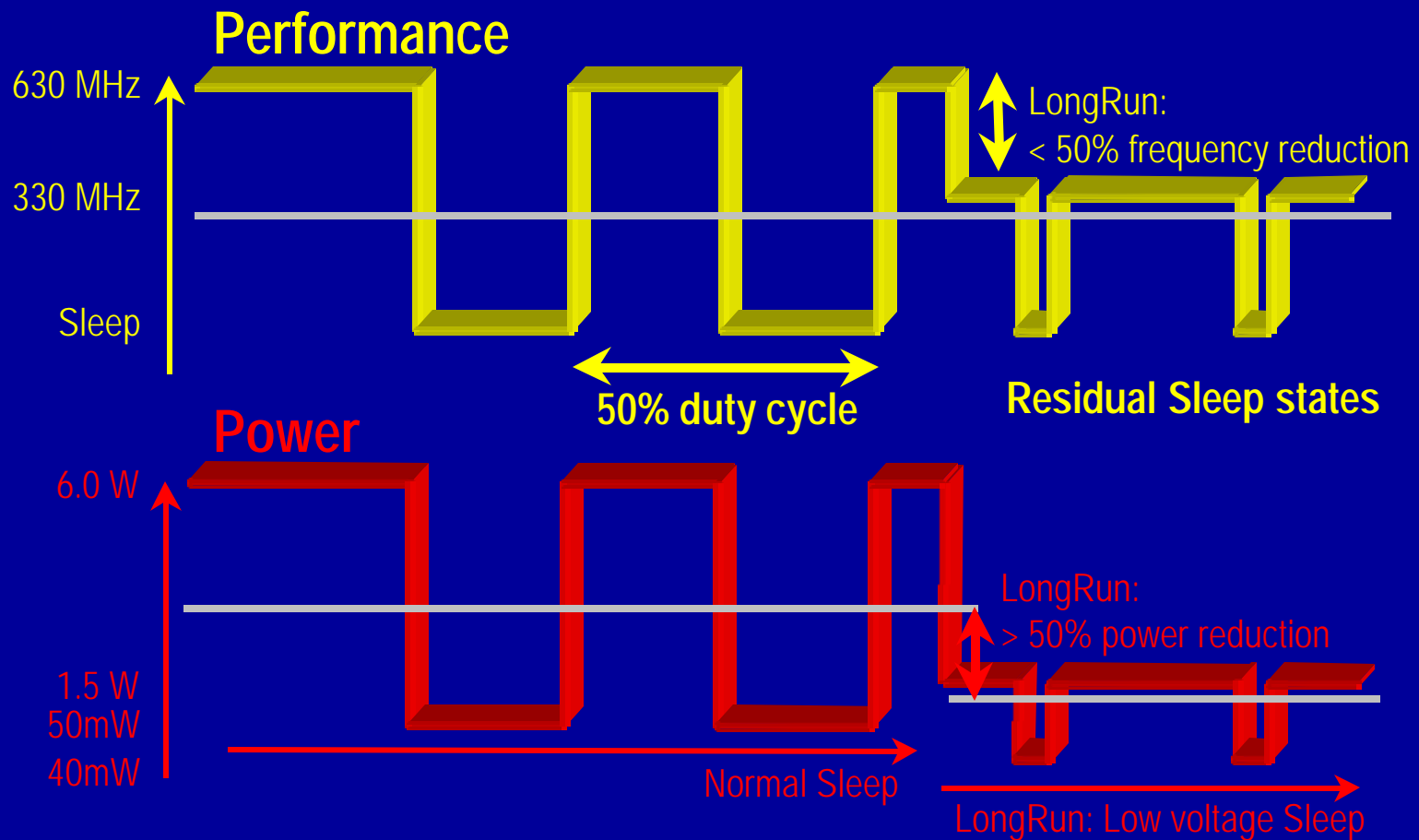

Transition Dynamics

Fast Frequency/Voltage Scaling

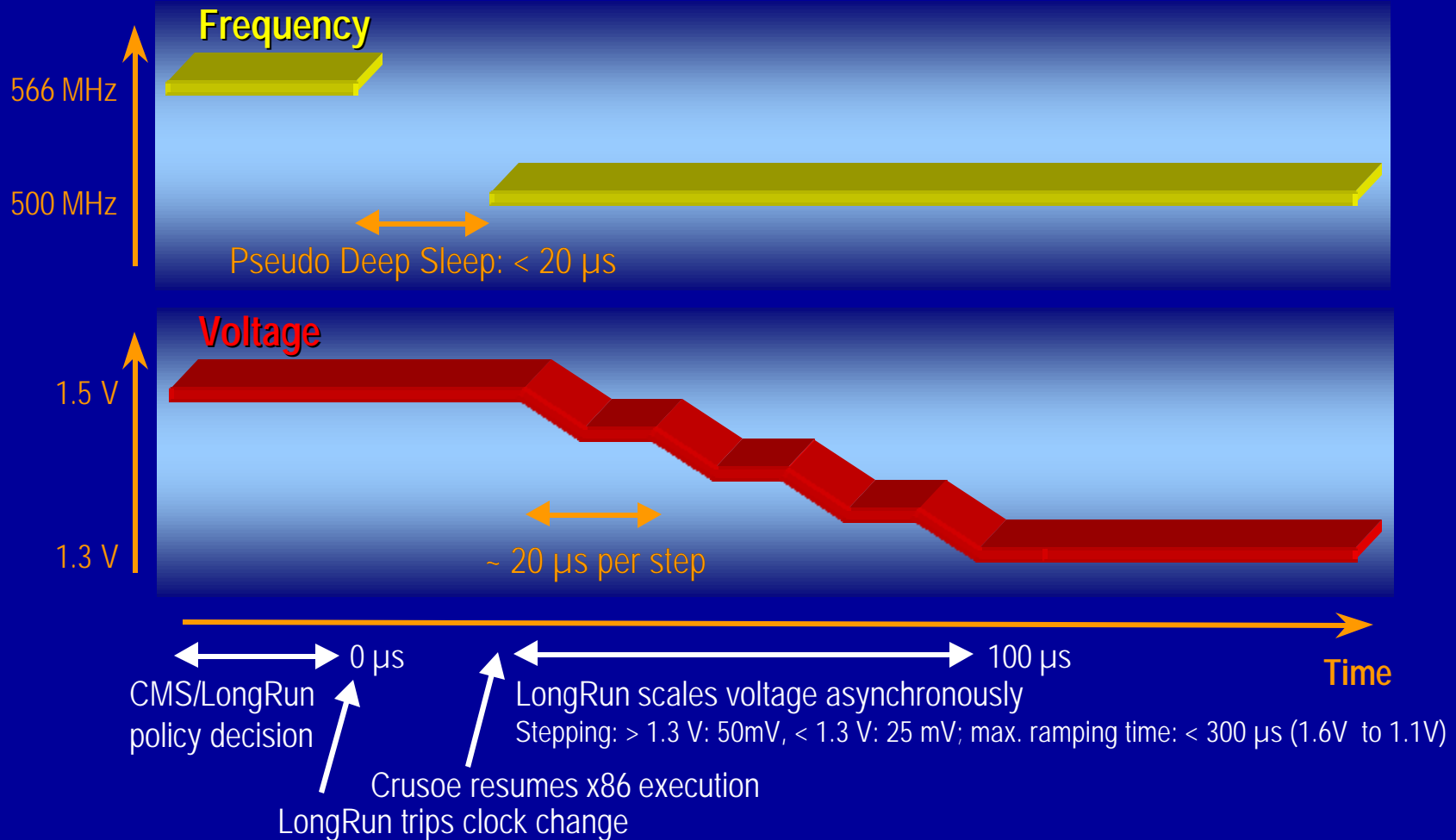

Transition Details

Voltage Scaling

- TM5400 Core Voltage is Fully Under Software Control
 - Code Morphing Software directly controls voltage regulator pins (via internal processor register)
 - OEM configurable
 - CPU output pin/voltage mapping
 - Voltage settling interval
- CMS Schedules Interrupts to Asynchronously Ramp Voltage
 - Allows sustained x86 forward progress during voltage ramping

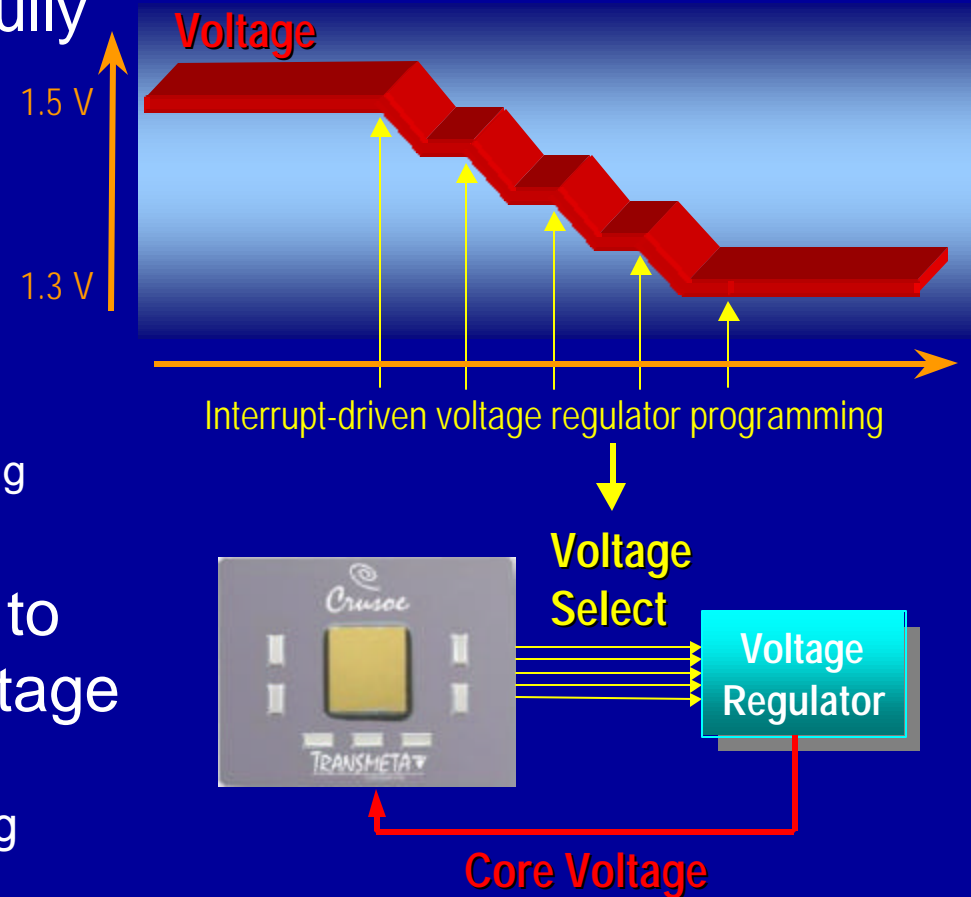

Programming Interface

Processor and Northbridge

Adaptive Power Control

CPU interface

CPUID 8086 0001h

EDX:0	LongRun supported
ECX	Nominal core frequency

CPUID 8086 0007h

EAX	Current core frequency
EBX	Current core voltage
ECX	Current performance percentage

MSR 8086 8010h

EDX	Upper boundary (% of max. performance)
EAX	Lower boundary (% of max. performance)

Advanced Thermal Control

Northbridge interface

Function 0, Register A8h

Bit 4	Thermal Management enabled
-------	----------------------------

Bit 1:3	Power reduction level
---------	-----------------------

Bits	Mode
000	Reserved
001	Reserved
010	75.0%
011	62.5%
100	50.0%
101	37.5%
110	25.0%
111	12.5%

Bit 0	LongRun supported
-------	-------------------

Energy Efficiency

Superior Performance in Small Form Factors

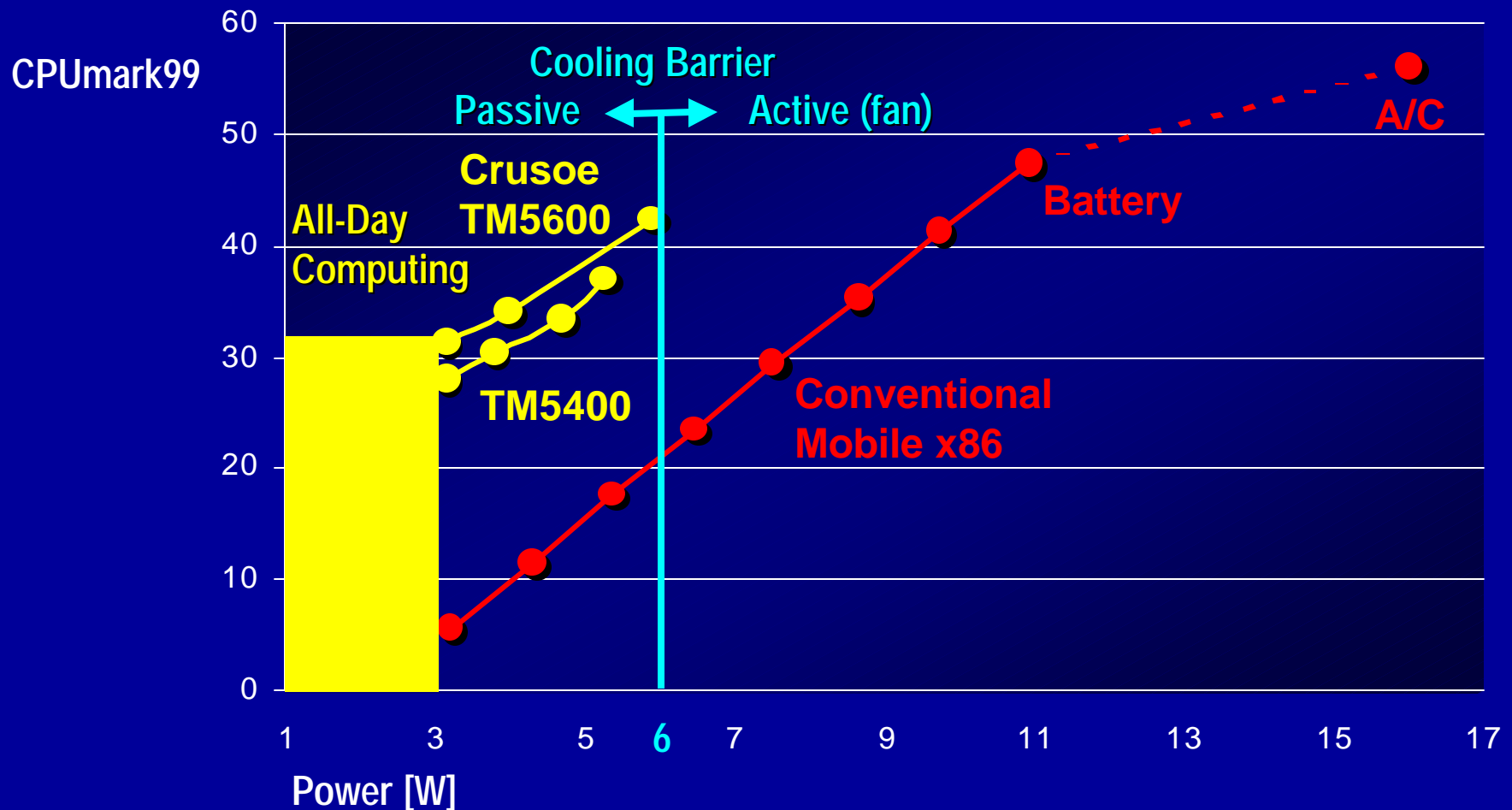

Energy Efficiency

Superior Performance in Small Form Factors

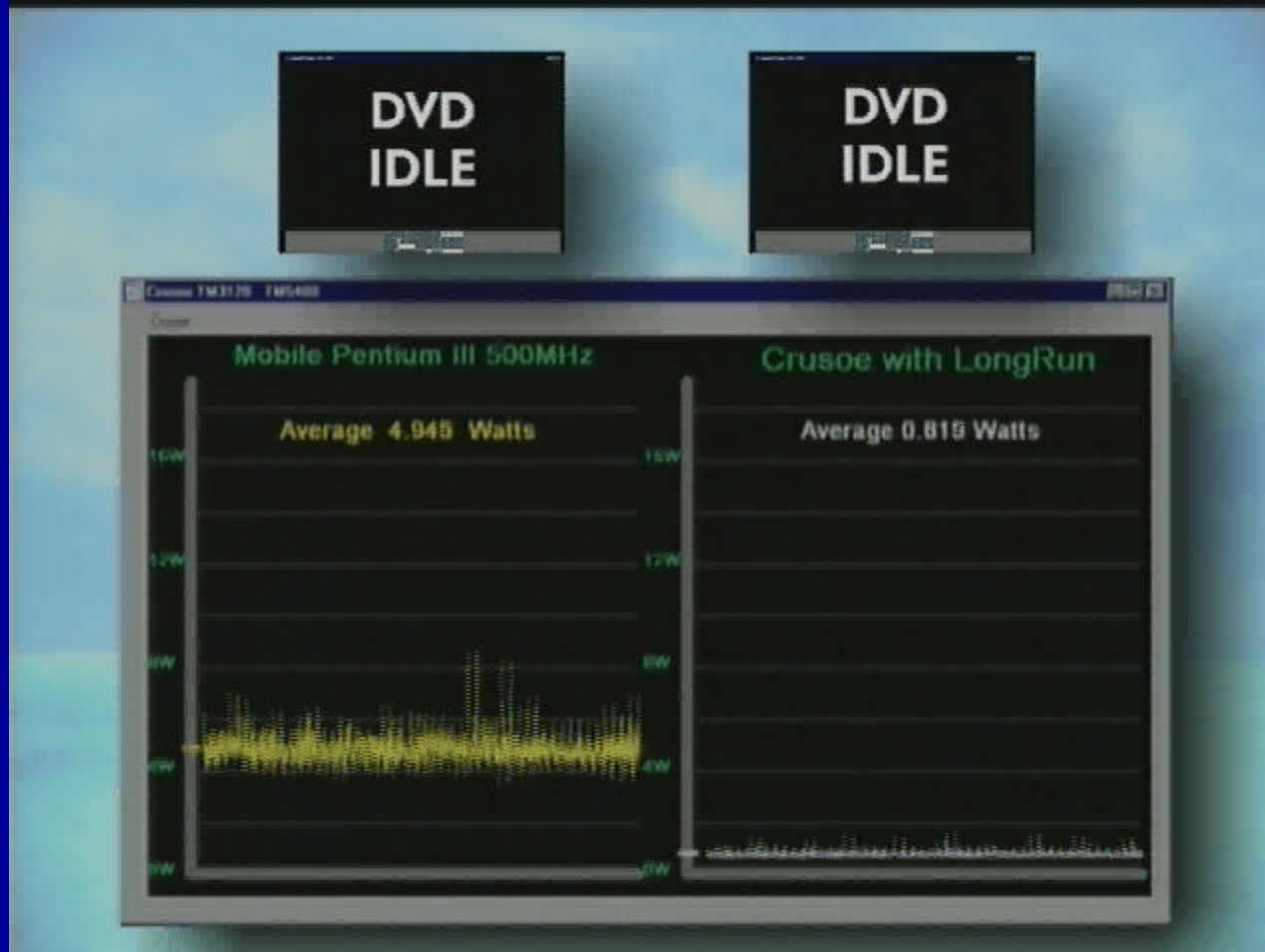

The LongRun Advantage

DVD Playback - Thermal Comparison

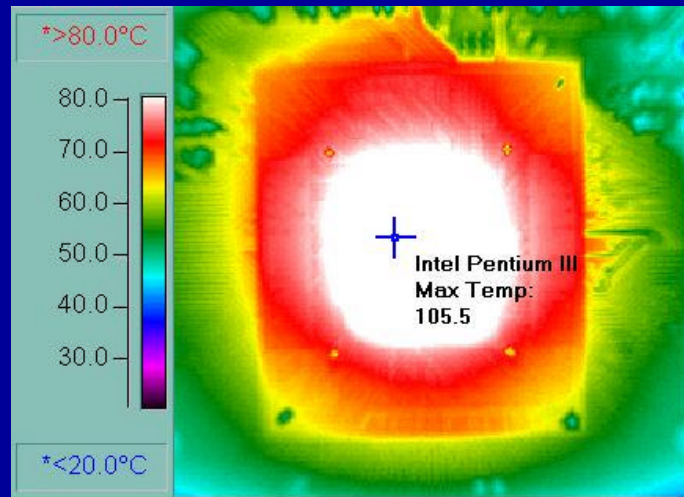

Conventional Mobile x86 Processor

105.5° C 221.9° F

Active thermal solution required
(Fan or overload protection)

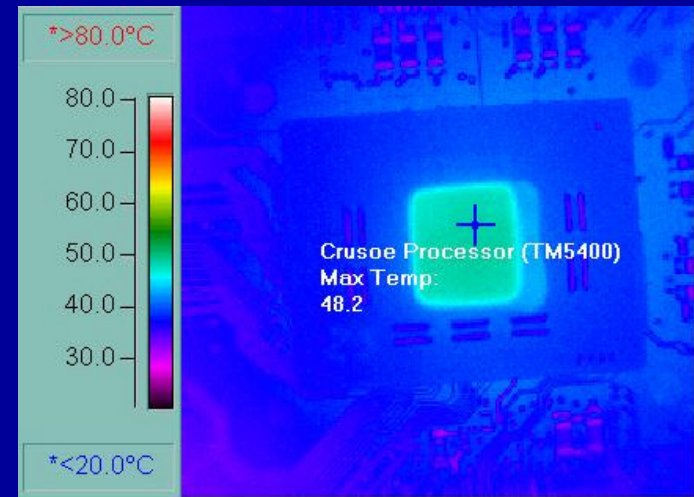

Crusoe TM5400 Processor with LongRun

48.2° C 118.8° F

Passive thermal solution
(No fan or overload protection)

Summary

- Crusoe Supports the x86 Power Management Model with Significantly Reduced Power Consumption
 - Sleep: 4× (C1) - 30× (C3) power savings
- Crusoe Leverages Code Morphing Software to Drive New Power Management - LongRun
 - Normal: 2× - 10× power savings
- Crusoe Leverages LongRun to Expand the Thermal Budget
- Crusoe's Low-Power Technology Portfolio
 - Allows a whole new class of battery-powered devices
 - The full PC and Internet experience - Anywhere and Anytime